

ACOUSTIC ROOMS



ACOUSTIC



SD GROUP



Silence in every detail, peace and comfort.



SD Acoustic Rooms offer the fastest way to create individual workspaces in open-plan office environments.

Thanks to the SD Acoustic Rooms designed in different sizes, you can hold meetings either individually or in Acoustic Rooms for two or four people.



SD Acoustic Rooms adapt to any office environment with different color options and modern designs.



SD Acoustic Rooms create a pleasant atmosphere for meetings with suitable furniture.

Soundproof Layers

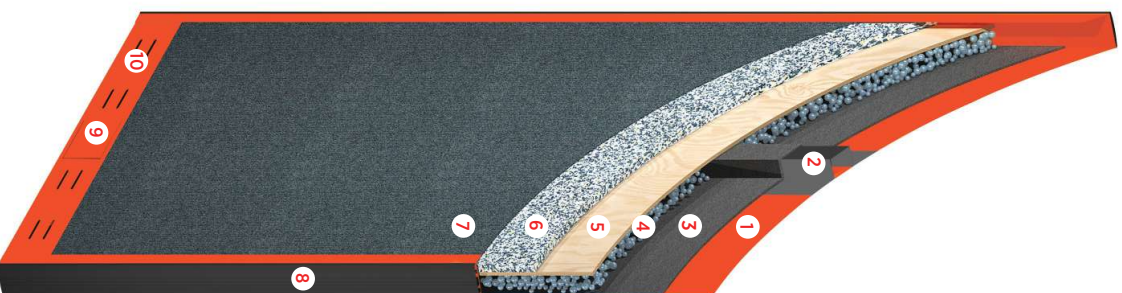
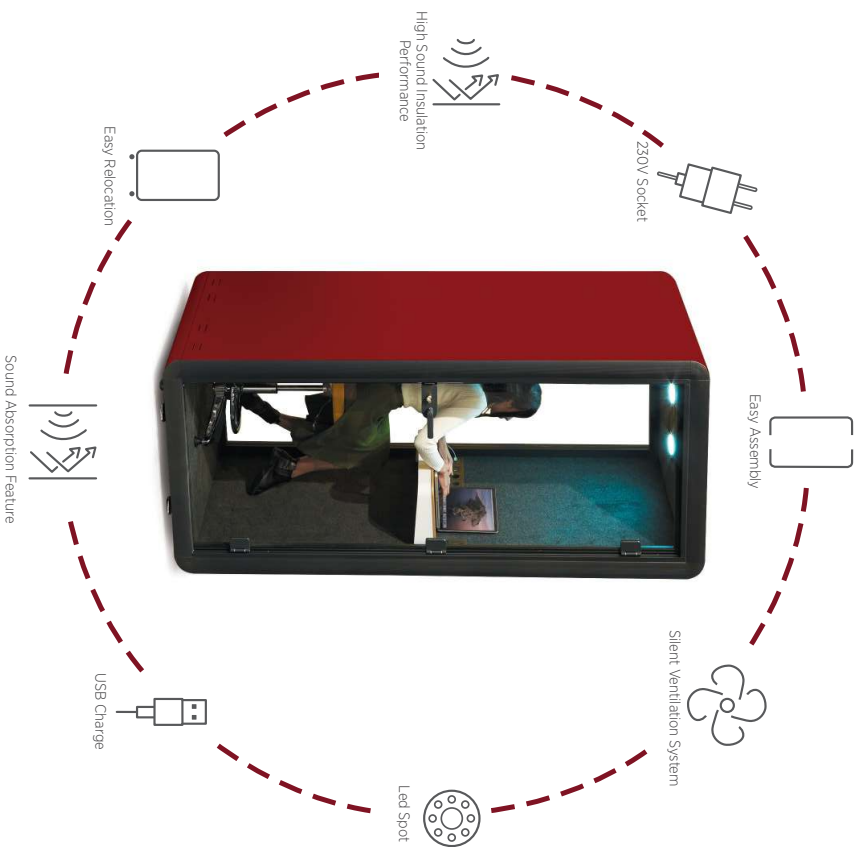

1-Sheet Steel
High quality powder coated metal side panels.

2-Steel Barrier
Barriers designed to strengthen the side panels.

3-EPDM Sponge
It has a very good sound insulation performance.

4-Empty Space
According to academic studies, it has been concluded that acoustic products made by leaving an air gap between the layers provide the best acoustic performance at all frequencies.

5-Wood Panel
It is a wooden board with very good mechanical strength.

6-Acoustic Foam
Absorb sound, echo and vibration. High frequency tones up to 80% and low frequency tones completely.

7-Acoustic Felt
With its special acoustic fiber structure, it is extremely resistant to impacts, cracks, dismantling and wear. Its rough surface absorbs the sound waves in the acoustic space.

8-Decorative Front Frame
Decorative front frame made of high-quality electrostatically powder-coated aluminum.

9-Protective Cover
Thanks to the 30 mah leakage current relay in the safety zone, the power supply is automatically interrupted if there is a risk of a leak in the acoustic booth, and safety is guaranteed.

10-Air Ducts
It allows fresh air from outside to enter the SD Acoustic Room.

Details

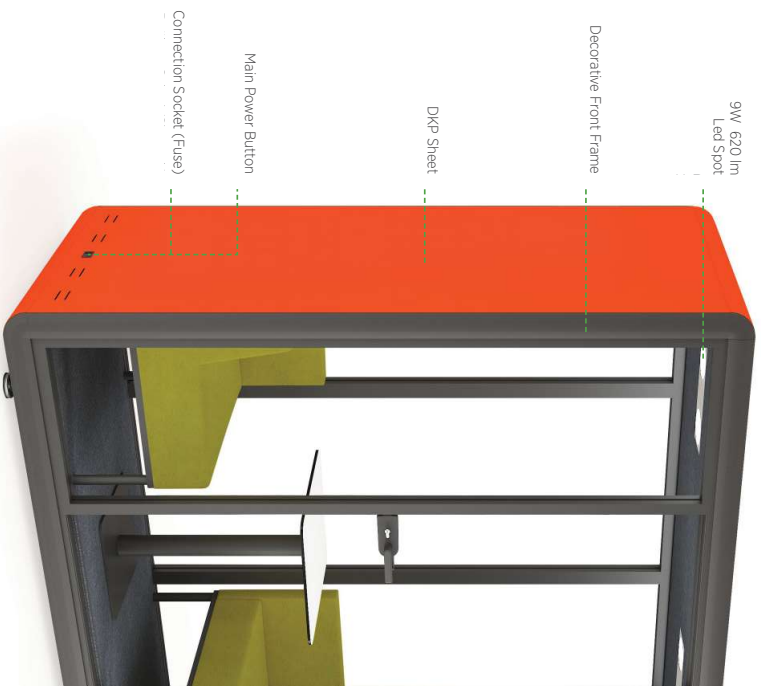
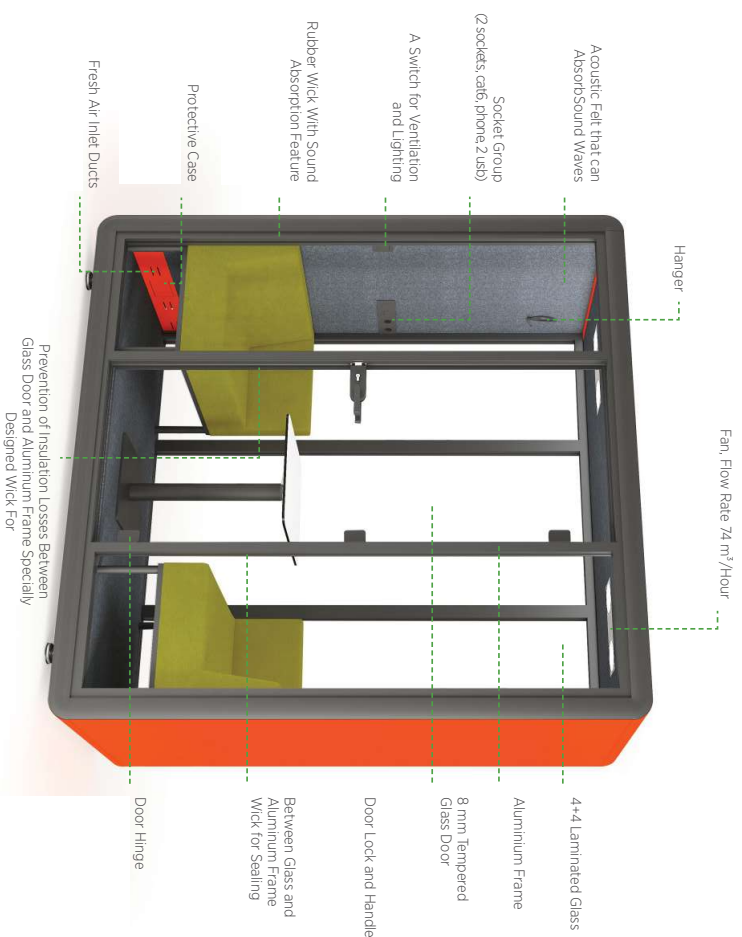

After determining the position of the SD Acoustic Room, it can be fixed with adjustable feet with vibration damping feature. High weight-resistant wheels provide easy displacement.

Height-Adjustable Fixing Foot

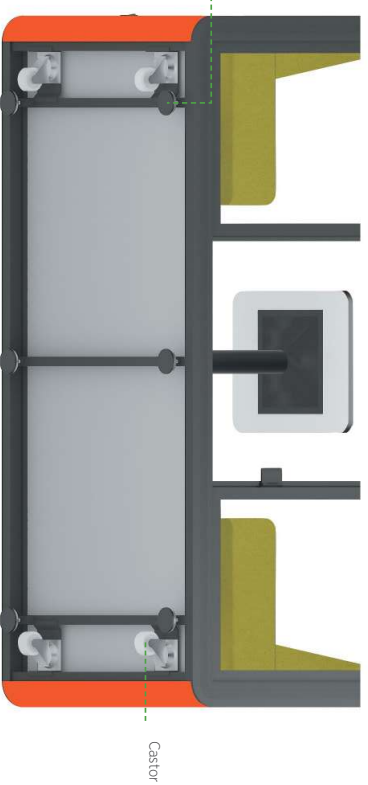

Optional

If desired, the socket group can be mounted on the floor.

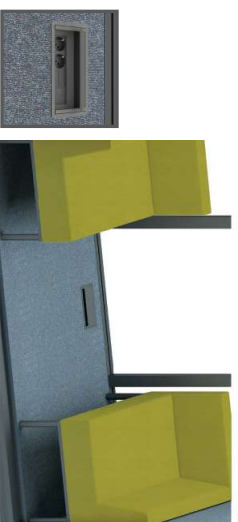

Exterior Colors



RAL 6018



RAL 1013



RAL 3003



RAL 7021



RAL 2008

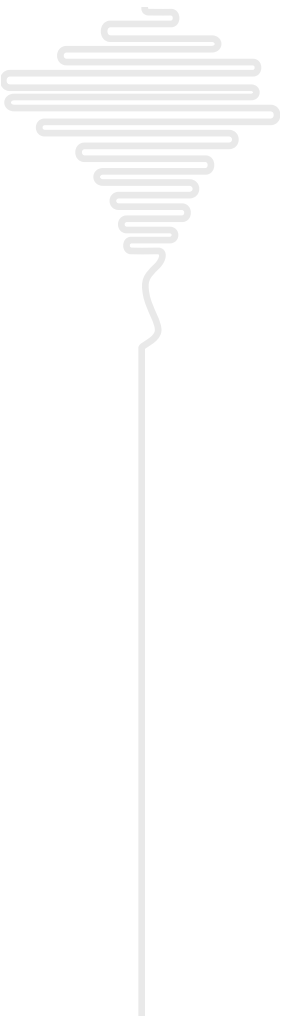

Upholstery Colors

Fabric

Prime Series



2205



2210



2215



2220



2225



2230



2235



2240



2250

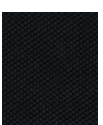

2255

Drop Series



1680



1687



1684

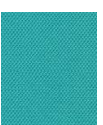

1689



1682



1688



1695



1686

Leather



1240



1505



6096



1510



1220



6156



6125



6080



6150



6170



6105



6146

Dimensions

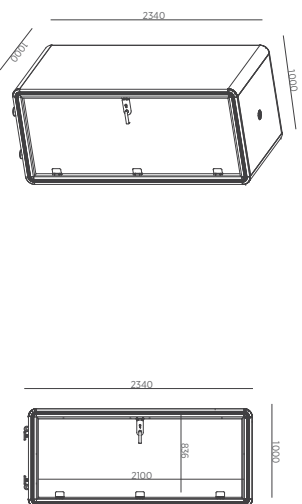

For 1 Person
2x9W/620 lm low electricity consumption
led spotlight
1 fans

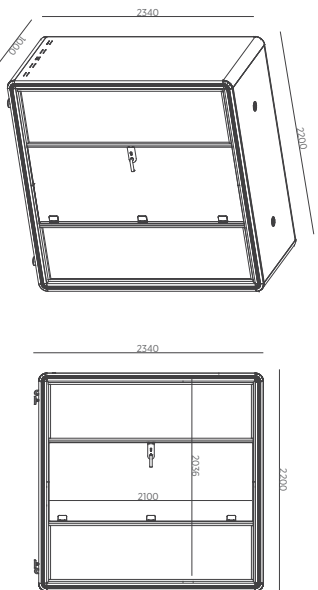

For 2 Persons
4x9W/620 lm low electricity consumption
led spotlight
2 fans

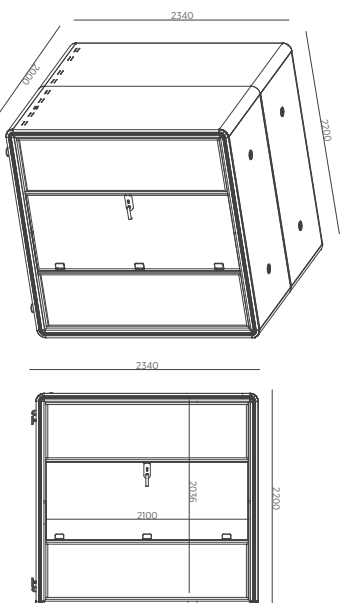

For 4 Persons
8x9W/620 lm low electricity consumption
led spotlight
2 fans

14 | 1 SD Acoustic Rooms

Technical Specifications

	Internal Width(mm)	Depth (mm)	Height(mm)
For 1 Person	1000	1000	2340
For 2 Person	2200	1000	2340
For 4 Person	2200	2000	2340

	Internal Width(mm)	Internal Depth(mm)	Internal Height(mm)
For 1 Person	836	852	2100
For 2 Person	2036	852	2100
For 4 Person	2036	1824	2100

Struktur

Lacquered side panels made of reinforced sheet metal, coated with high quality electrostatic powder. Electrostatically powder-coated aluminum profile acoustic cabin frame 80 mm wide 4 + 4 laminated glass with aluminum frames at the front and rear. Glass door 8mm hardened impact resistant. Lower and upper frame reinforced with steel profiles. Weight-resistant lower wheels make it easier to move the acoustic cabin. The inner surfaces of the cabins are covered with acoustic felt, extremely resistant to impacts, cracks, sound absorption is ideal.

Electrical System

3 m long with plug so that the system can be easily connected to the office electrical system. Main switch and AC power input socket with fuse 30 mA/h leakage current relay which automatically cuts the electricity to the acoustic cabinet in the event of an electrical leak and prevents possible dangers. 2x9W/620 lm low electricity consumption led spotlight for single room. 4x9W/620 lm low electricity consumption led spotlight for double room. 8x9W/620 lm low electricity consumption led spotlight for quadruple room. 2 sockets, 1 cat6 socket, 1 telephone socket, 2 USB port and 1 switch for lighting and ventilation system.

Ventilation System

Quiet fan with an air flow rate of 74 m³/hour. 1 fan in the cabin for one person. 2 fans in the double cabin. 2 fans in the four-compartment cabin. The fans are activated by the switch.

Sound Insulation

During the measurements of the National Metrology Institute TÜBİTAK according to ISO 23551-1, the speech attenuation value was measured with 32 dB and the S_A value with 20.8 dB at a frequency of 8000 Hz.

WD GROUP



For those who prefer silence.

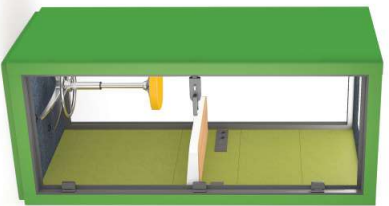

When the focus is reached, ideas come true and applied. Our silent and mobile cabins, meeting rooms, is designed to meet private office or quiet workspace needs.



WD Acoustic Rooms help you create quiet spaces.

Soundproof Layers

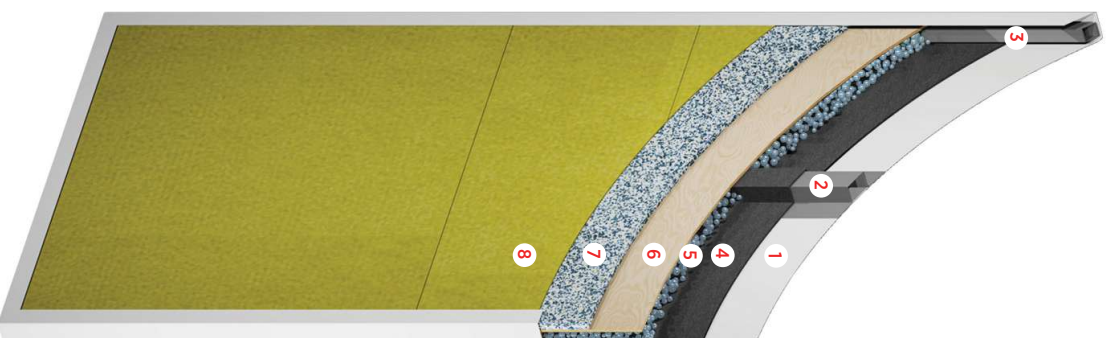

1-Sheet Steel

High quality powder coated metal side panels.

2-Steel Barrier

Barriers designed to strengthen the side panels.

3-Steel Skeleton

Steel inner skeleton designed to strengthen the body.

4-EPDM Sponge

It has a very good sound insulation performance.

5-Empty Space

According to academic studies, it has been concluded that acoustic products made by leaving an air gap between the layers provide the best acoustic performance at all frequencies.

6-Wood Panel

It is a wooden board with very good mechanical strength.

7-Acoustic Foam

Absorb sound, echo and vibration, High frequency tones up to 80% and low frequency tones completely.

8-Acoustic Fabric

With its special acoustic fiber structure, it is extremely resistant to impacts, cracks, dismantling and wear. Its rough surface absorbs the sound waves in the acoustic space.

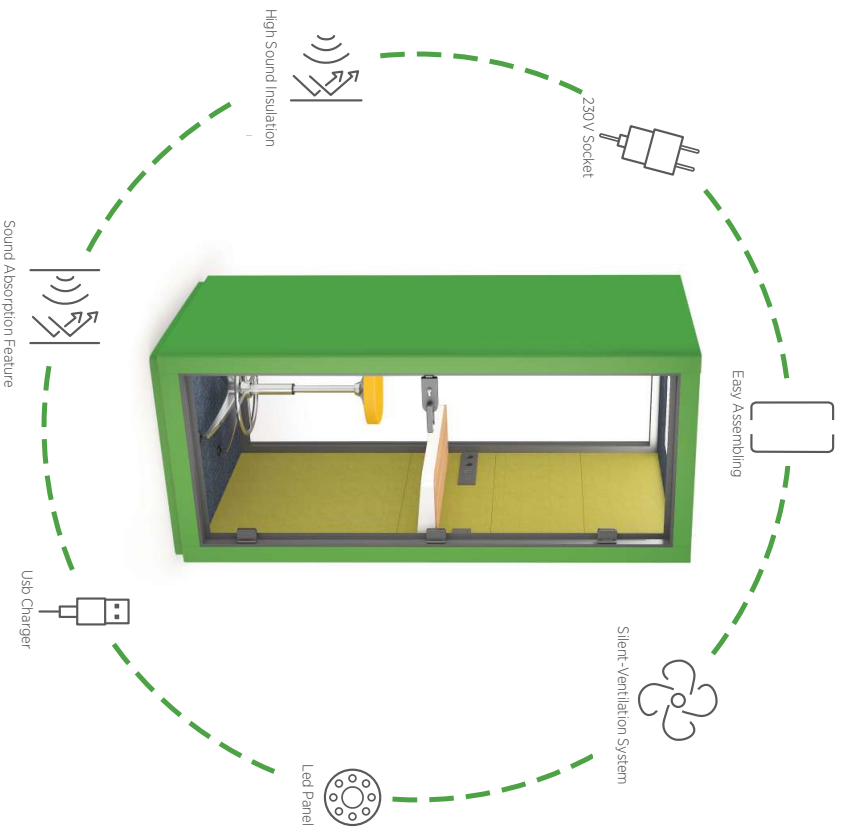

Details

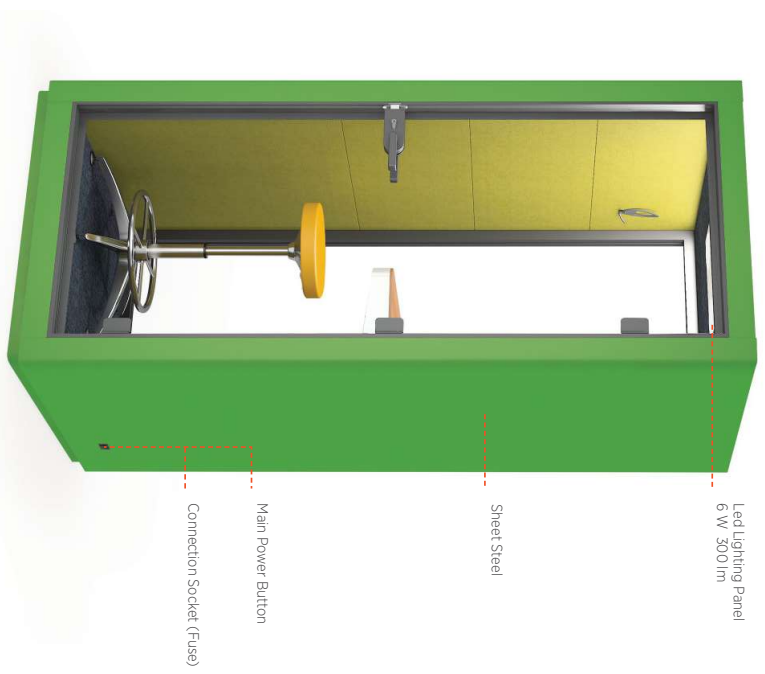
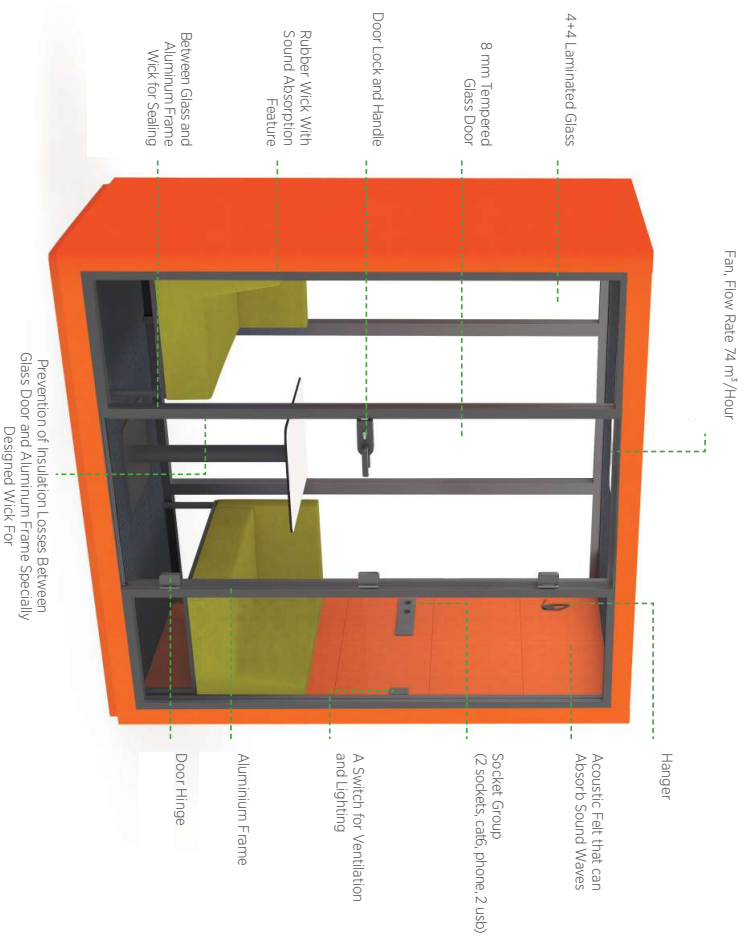

Optional
If desired, the socket group can be mounted on the floor.



Exterior Colors



RAL 6018



RAL 1013



RAL 3003



RAL 7021



RAL 2008

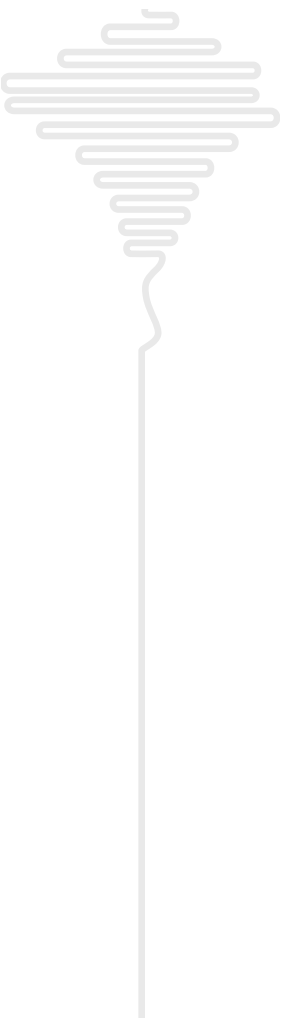

Upholstery Colors

Fabric

Prime Series



2205



2210



2215



2220



2225



2230



2235



2240



2250



2255

Drop Series



1680



1687



1684



1689



1682



1688



1685



1686

Leather



1240



1505



6096



1510



1220



6156



6125



6080



6150



6170



6105



6146

Dimensions

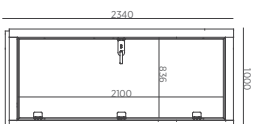
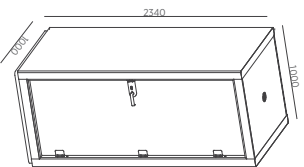

For 1 Person
2x6W/300 lm low electricity consumption
led lighting panel
1 fans

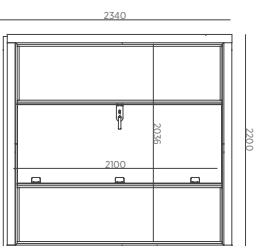
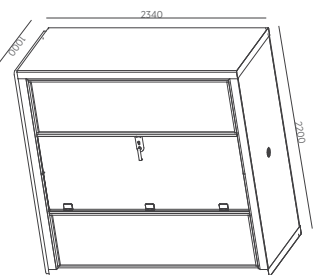

For 2 Persons
2x6W/300 lm low electricity consumption
led lighting panel
1 fans

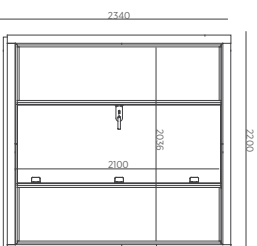
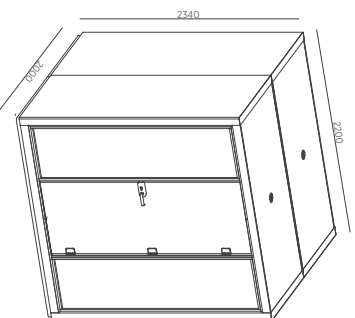

For 4 Persons
4x6W/300 lm low electricity consumption
led lighting panel
2 fans

26 | WD Acoustic Rooms

Technical Specifications

	Internal Width(mm)	Depth (mm)	Height(mm)
For 1 Person	1000	1000	2340
For 2 Person	2200	1000	2340
For 4 Person	2200	2000	2340

	Internal Width(mm)	Internal Depth(mm)	Internal Height(mm)
For 1 Person	836	875	2100
For 2 Person	2036	875	2100
For 4 Person	2036	1875	2100

Struktur

Lacquered side panels made of reinforced sheet metal, coated with high quality electrostatic powder
 4+4 laminated glass with aluminum frames at the front and rear
 Glass door 8 mm hardened impact resistant
 Lower and upper frame reinforced with steel profiles
 WD Acoustic Room inner side surfaces are covered with acoustic fabric that is extremely resistant to impacts and tears, with sound absorption feature
 WD Acoustic room inner floor and ceiling surfaces are covered with acoustic felt, which is extremely resistant to impacts and tears, with sound absorption feature

Electrical System

3 m long with plug so that the system can be easily connected to the office electrical system
 Main switch and AC power input socket with fuse
 2x6W/300 lm low electricity consumption led lighting panel for single room
 2x6W/300 lm low electricity consumption led lighting panel for double room
 4x6W/300 lm low electricity consumption led lighting panel for quadruple room
 2 sockets, 1 cable socket, 1 telephone socket, 2 USB port and 1 switch for lighting and ventilation system

Ventilation System

Quiet fan with an air flow rate of 74 m³/hour
 1 fan in the cabin for one person
 2 fans in the double cabin
 2 fans in the four-compartment cabin
 The fans are activated by the switch

